

PANORAMIC 1417 - UK



The supremacy of ideas.

PANORAMIC

P 40.17

P 40.16

P 40.14



PERFORMANCE AND DIMENSIONS



Cab

- Complies with ISO 3449 (FOPS) and ISO 3471 (ROPS) standards.
- Lever controls or optional '4 x 1' electro-mechanical joystick with roller-operated proportional control.

Boom

- Telescopic, with sections sliding on adjustable low-friction pads.
- Hydraulic extension mechanism, hydraulic pipes and electrics are totally enclosed within the boom assembly to ensure maximum protection and reliability.
- Integral boom side-shift mechanism.

Quick-attach carriage

- The Tac-Lock quick attachment fitting system is hydraulically controlled from the cab.
- Standard double-acting hydraulic service, with quick couplings, for the operation of hydraulically powered attachments.

Frame levelling

- Hydraulically operated from the cab.

Front stabilisers

- Independently controlled with automatic lock when the boom exceeds the preset safety angle.

Forks

- Floating type. Length 1200mm. Section 130 x 50mm.
- Fork spacing is manually adjustable between 450 and 1010mm.

Steering

- Four drive/steer wheels, with automatic wheel synchronisation in the event of any misalignment and selection of three steering modes from the cab.

Engine

- Direct injection, water cooled, 4 cylinder Deutz Euro 2 turbo diesel engine producing 74.9kW-102HP at 2400rpm (97/68/CE).

Transmission

- Hydrostatic with electronically controlled variable displacement pump.
- Continuous and automatic speed variation, from zero to maximum speed, solely with the accelerator pedal.
- Two-speed mechanical range gearbox.
- Inching-Control pedal to proportionately reduce travel speed whilst maintaining

high engine speed for hydraulic operation e.g. during loading operations.

- Finger-Touch system makes it possible to change between forward and reverse direction with the driver keeping both hands firmly on the steering wheel.
- Permanent four-wheel drive.
- Portal axles ensuring excellent ground clearance.

Braking system

- Disk service brakes on all 4 wheels, hydraulically operated and acting on the differential output shafts.
- Disk parking brake with automatic locking feature and hydraulic release control, acting on the main transmission shaft.

Hydraulic system

- Variable delivery Load-Sensing pump.
- Maximum operating capacity: 108lpm.
- Working pressure: 210bar.

Electrics

- 12V system with 100Ah battery and 90A alternator.
- Full road lighting and rotating beacon.
- Manual battery isolator switch (optional automatic switch).

Service capacities

- Hydraulic oil: 140 litres
- Diesel fuel: 150 litres
- Hydrostatic oil: 12 litres
- Engine oil: 8.5 litres
- Coolant: 12 litres

Tyres

- 405/70-24.

Available options

- Rear axle differential lock.
- Automatic battery isolator.
- Manual control air conditioning.
- Windscreen wiper on the roof window.
- Four working lights on the cab (two front lights and two rear).
- Pneumatic seat.
- Roof and front window mounted sun blinds.

Boom side-shift - a Merlo exclusive

The integral chassis side-shift mechanism gently swings the upper part of the chassis, and with it, the telescopic boom across the longitudinal axis of the machine. The load can be precisely placed without repositioning the machine. Using the side-shift mechanism in no way detracts from the performance or stability of the PANORAMIC as it is an integral part of the design, not a mere attachment, and produces the following maximum sideways displacement.

PANORAMIC		P 40.17	P 40.16	P 40.14
Side-shift	mm	± 435	± 410	± 375

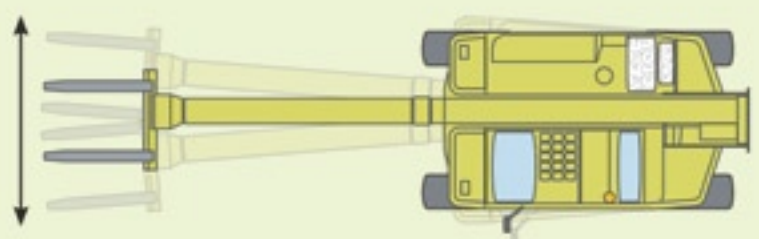

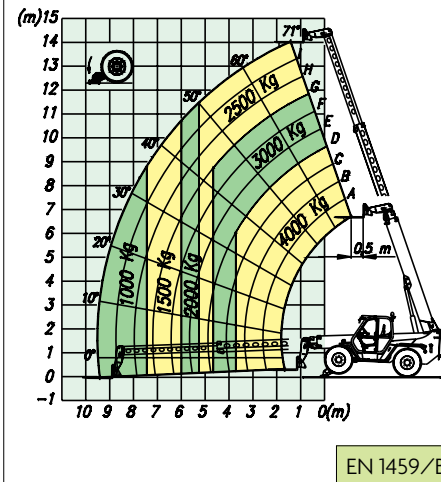
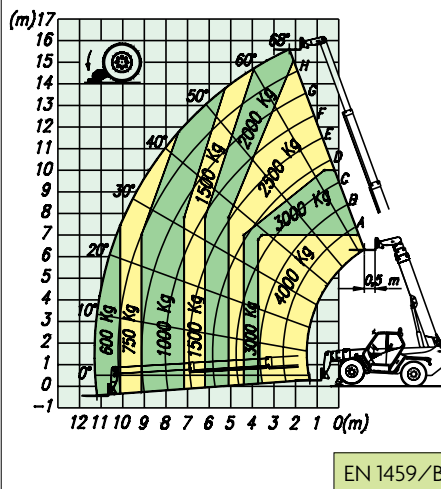
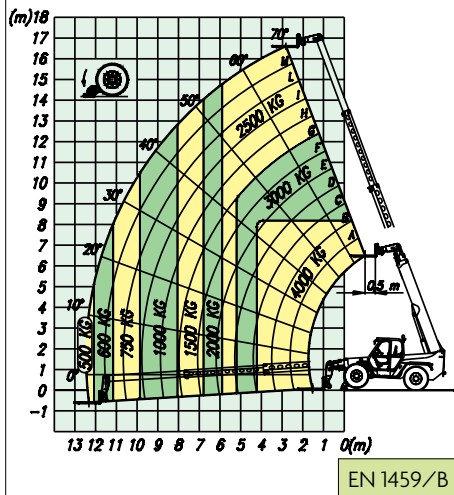

PANORAMIC		P 40.17	P 40.16	P 40.14
Weight				
Total empty weight (with forks)	kg	10400	10300	9900
Performance				
Rated maximum load	kg	4000	4000	4000
Maximum lift height	m	16,7	15,6	14
Maximum forward reach	m	12,5	11,4	9,5
Lift height at full capacity	m	8,1	7	9,6
Reach at full capacity	m	4,2	3,7	3,8
Capacity at full lift height	kg	2500	2000	2500
Capacity at full forward reach	kg	500	600	1000
Low emission (Euro 2) engine		turbo		
Power at 2400rpm (97/68/CE)	kW/HP	74,9/102		
Speed ratios				
1 st gear	kph	16	16	16
2 nd gear (self-limiting maximum speed)	kph	40	40	40

PANORAMIC		P 40.17	P 40.16	P 40.14
Dimensions				
A	mm	5795	5575	5890
B	mm	1605	1385	1700
C	mm	2875	2875	2875
D	mm	1315	1315	1315
E	mm	4790	4790	4790
F	mm	480	480	480
H	mm	2400	2400	2400
L	mm	2600	2600	2600
M	mm	995 ⁽¹⁾	995 ⁽¹⁾	995 ⁽¹⁾
P	mm	2510	2510	2510
R	mm	4050	4050	4050
S	mm	5110	4990	5040
Z	mm	850	850	850

⁽¹⁾ Useful internal width.

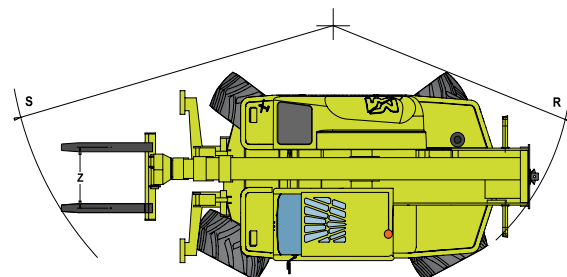
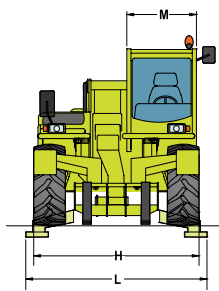
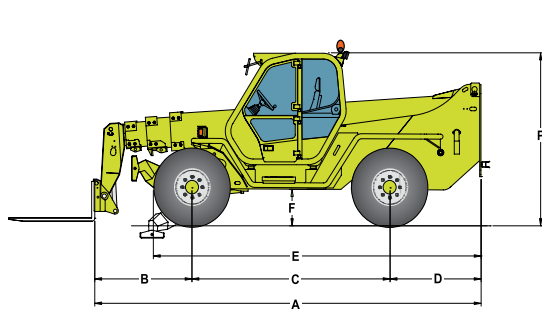

WINCHESTER

SALISBURY

SOUTHAMPTON

01962 851155

01722 341155

02380 667666

Suppliers of Plant & Access Hire Equipment